

Low Pressure Transmitter in Short and Compact Design

S I S

Main features

- Measuring ranges 0...0.6 bar to 0...40 bar
- Standard signals for the industry, hydraulics and pneumatics
- Plug systems MVS/A acc. to DIN EN 175301-803 A, MVS/C acc. to DIN EN 175301-803 E
- NEW >>> small design ~ max. 50 mm in length
- NEW >>> large variety of electrical connections

Applications

- General industrial applications
- Hydraulics
- Pneumatics
- Mechanical engineering
- Automotive industry
- Plant engineering and automation technology

Description

For its short design, it can be applied in largely confined space for installation. The SIS series distinguishes itself by a high degree of variability of both the electrical and mechanical connecting options. Moreover, its proven modular concept provides for use of the most common types of signals in industry and it also allows manufacture at reasonable cost, also in small batches.



Specifications

Pressure range								
Measuring range*	p [bar]	0,6	1,0	1,6	2,0	2,5	4,0	6,0
Overload pressure	p [bar]	6	6	6	6	6	10	20
Burst pressure	p [bar]	9	9	9	9	9	15	30
Measuring range*	p [bar]	10	16	20	25	40		
Overload pressure	p [bar]	20	40	40	100	100	(vacuum, relative pressure, +-	
Burst pressure	p [bar]	30	60	60	150	150	or absolute pressure are available)	
Electrical parameter								
		signal			U_s [V _{DC}]	R_L [k Ω]	RA [Ω]	
Output signal * and	R_A in Ohm	4...20 mA	(2-wire, 3-wire)		9...32		acc. to $R_A = < (U_s - 10V) / 0,02 A$	
maximum acceptable burden R_A		0...10 V _{DC}	(3-wire)		12...32	> 5,0		
		1...5 V _{DC}			8...32	> 1,0		
		0,5...4,5 V _{DC}	ratiometric		5 \pm 10%	> 4,7		
Response time * (10-90%)	t [ms]	< 1						
Withstand voltage	U [V _{DC}]	350						
Accuracy								
Accuracy @RT	% of the range	$\leq 1,00^{**}$	option $\leq 0,50$		** incl. nonlinearity, hysteresis, repeatability, zero-offset- and final-offset (acc. to IEC 61298-2)			
	BFSL	$\leq 0,25$						
Non-linearity	% of the range	$\leq 0,15$						
Repeatability	% of the range	$\leq 0,10$						
Stability/year	% of the range	$\leq 0,10$						
Acceptable temperature ranges								
Measuring medium	T [°C]	-40...105						
Ambience	T [°C]	-40...85						
Storage	T [°C]	-40...105						
Compensated range*	T [°C]	-10...70						
Temperature coefficient within the compensated range								
Mean TC offset	% of the range	$\leq 0,15 / 10K$						
Mean TC range	% of the range	$\leq 0,15 / 10K$						
Total error	% of the range	-40°C	3,00%					
	% of the range	85°C	2,00%		125°C	2,00%		
Mechanical parameter								
Parts in contact with the measuring medium*	silicon, stainless steel, brass, plastic							
Housing*	silicon, stainless steel, brass, plastic							
Shock resistance	g	1000	acc. to IEC 68-2-32					
Vibration resistance	g	20	acc. to IEC 68-2-6 and IEC 68-2-36					
Mass	m [g]	80-120	(depending on design)					
CE - conformity	EC Directive 89/336/EWG							
IP system of protection	The IP system of protection as specified in the data sheets generally applies, with their mating plug connected. Relative pressure transmitters usually require a ventilated mating plug and/or cable to allow for pressure							
* other upon request	compensation. From a pressure range of 60bar, a ventilated mating plug and/or cable is not necessarily required.							

Configurations -examples-

SIS with

Round connector DIN 72585

Junior-Timer connector

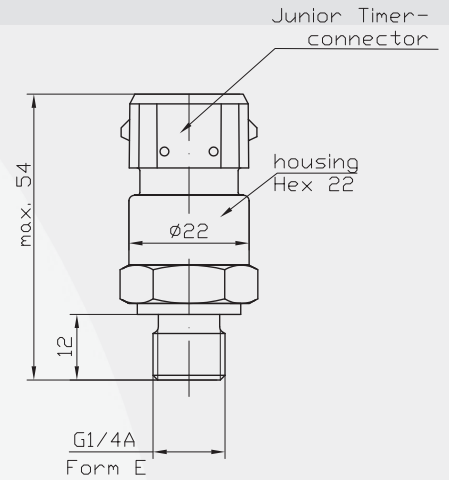
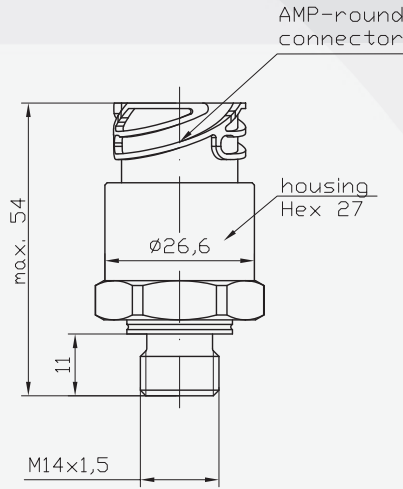

Connectors*

MVS/C
DIN EN 175301-803

MVS/A
DIN EN 175301-803

Junior-Timer
connector

Packard
connector

Superseal
connector

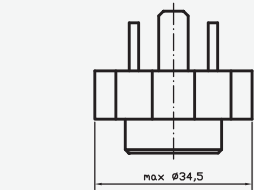
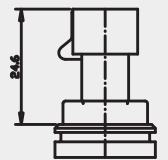
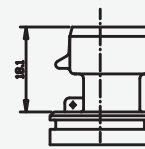
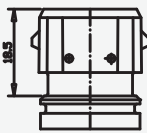
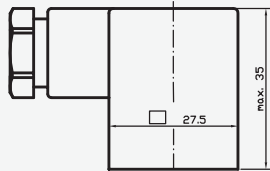

Round connector
DIN 72585

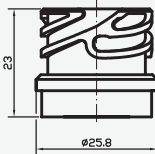

Deutsch-
connector 4-contacts

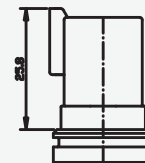

Pressure Connections*

G 1/4 A;
DIN 3852; Form E

1/4 NPT

M 14x1,5;
DIN 3852; Form E

7/16-20UNF-2A
SAE 514

3/8-24UNF-2A

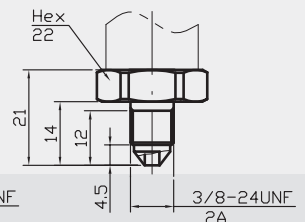
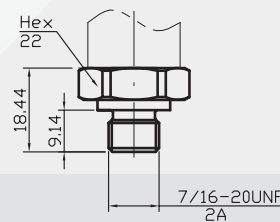
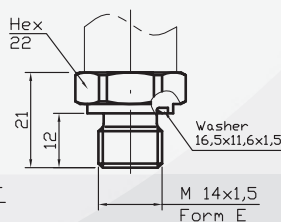
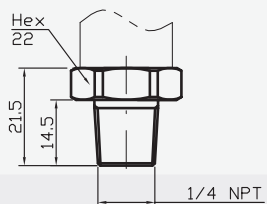
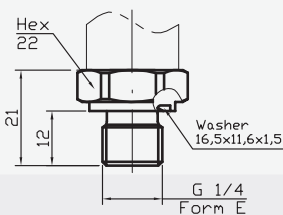

* custom-made adjustments acc. to pressure connections and connecting options are possible

Electrical Connections* (left: 2-wire, right: 3-wire)

Deutsch
connector
4 contacts

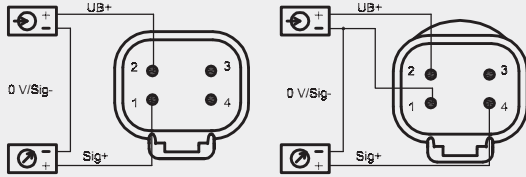

Junior-Timer
connector

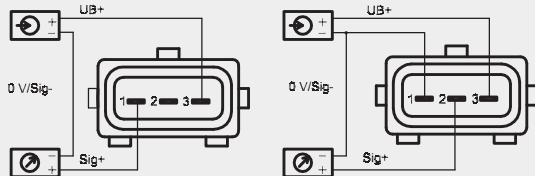

Packard-
connector

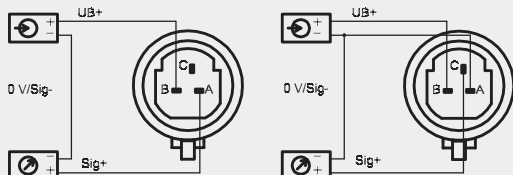

Round
connector
DIN 72585

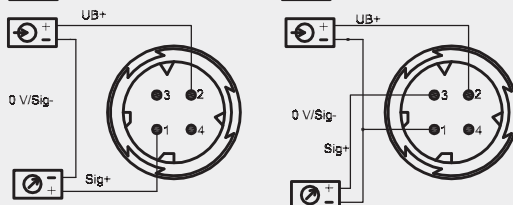

Superseal
connector

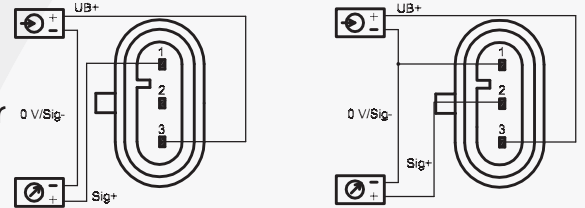

MVS/A
DIN EN
175301-803

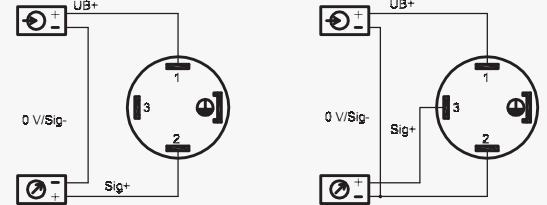

MVS/C
DIN EN
175301-803

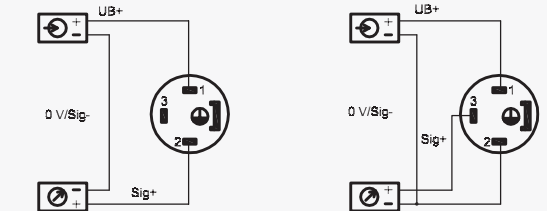

Legend

power supply
 consumer

red
 black
 white

* custom-made adjustments acc. to pressure connections and connecting options are possible

Product line

DS4	Electronic Pressure Switch	SMC	Pressure Transmitter with CANopen Interface
DPSX9I	Intrinsically Safe Electronic Pressure Switch for Current	SME	Pressure Transmitter in Miniature Design
DPSX9U	Intrinsically Safe Electronic Pressure Switch for Voltage	SMF	Pressure Transmitter with Flush Diaphragm
PS1	Level Sensor	SMH	High Pressure Transmitter
PSX2	Intrinsically Safe Level Sensor	SML	Pressure Transmitter for Industrial Application
SHP	High Precision Pressure Transmitter	SMO	Pressure Transmitter in Mobile Hydraulics
SIS	Low Pressure Transmitter in Short and Compact Design	SMS	OEM Pressure Transmitter for Hydraulics and Pneumatics
SIL	Low Pressure Transmitter for Industrial Application	SMX	Intrinsically Safe Pressure Transmitter for Industrial Application
SKE	High Temperature Pressure Transmitter with Detached Electronics	TPS	Multi-Function Transmitter for Pressure and Temperature
SKL	High Temperature Pressure Transmitter with Cooling Fins		